

AGRIFARM / PLANTO / RENOLIT

Lubricants for Agriculture



LUBRICANTS.
TECHNOLOGY.
PEOPLE.



LUBRICANTS. TECHNOLOGY. PEOPLE.

We focus consistently on high-quality lubricants and related specialties.

We develop innovative and holistic solutions for a wide variety of applications.

We value the high level of commitment of our employees and their trusting interaction with one another.



Facts and figures

Company: FUCHS SCHMIERSTOFFE GMBH, a company of the FUCHS Group

Headquarters: Mannheim

Product range: A full range of more than 2,000 products and 6,000 articles

Certifications: IATF16949, DIN ISO 14001, BS OHSAS 18001, ISO 50001

References: One of the leading lubricants OEM for the German automotive industry

FUCHS has developed, produced and sold high-quality lubricants and related specialties for more than 85 years – for virtually all areas of application and sectors. With over 100,000 customers and 62 companies worldwide, the FUCHS Group is the leading independent supplier of lubricants.

A team of more than 950 specialists across Germany works to guarantee the satisfaction of our customers. Whatever their requirements, we have the ideal lubricant for their specific applications and processes. In our technology center we link interdisciplinary expertise in a quick and efficient way – and work on innovative lubricant solutions to meet the demands of today and tomorrow every single day.

FUCHS lubricants stand for performance and sustainability, for safety and reliability, for efficiency and cost savings. They represent a promise: technology that pays off.



AGRIFARM
SAFETY IS OUR STRENGTH

With AGRIFARM lubricants, you are placing your trust in a wealth of experience gathered over the course of decades. FUCHS has been active in the agricultural lubricant market for more than 70 years, both as an OEM for machine manufacturers and in the field of workshop services. The latest innovative lubricants under the AGRIFARM brand secure maximum operational reliability of all agricultural units – from engines and transmissions, right through to hydraulics in all machines and vehicles.

Safety during application

AGRIFARM lubricants have proved extremely successful even under the very toughest conditions and thereby offer the highest level of reliability for your vehicle fleet.

AGRIFARM will make the difference for you

AGRIFARM products are lubricants of the very highest quality made by FUCHS, which meet the latest standards of leading manufacturers in terms of application safety. FUCHS only uses selected base oils and specially developed additives for the manufacturing of AGRIFARM lubricants.

Our expertise guarantees the greatest reliability. AGRIFARM is the worldwide specialist for high-end lubricants

Agricultural machines must deliver top performance on a daily basis. As a professional, you know how decisive the right oil is for the performance and durability of such a machine. So place your trust in the FUCHS AGRIFARM range of high-tech lubricants.

Noticeably increased oil change intervals in engines and significantly fewer signs of wear are just some of the visible results.

Special lubricants for agriculture

Alongside lubricants that can only be used for a certain component there are also the all-rounders: the STOU and UTTO products that come into use in agricultural applications.

Both were developed for use in transmission and hydraulic systems and can also be deployed in brakes designed to run in an oil bath (wet brakes).

STOU products can also be used in an engine if the respective specifications are met. In other words, a STOU is an UTTO with engine performance. An overview is provided in the table below.

Aggregate	UTTO*	STOU**
Engine (with or without turbocharging)		X
Manual gearboxes	X	X
Gearboxes and gearbox-hydraulic systems with or without integrated wet brakes	X	X
Hydraulic systems	X	X
Final drives	X	X

*UTTO = Universal Tractor Transmission Oil

**STOU = Special Tractor Oil Universal

Limited Slip (LS)

LS lubricants are gear oils for differentials with disc lock, which guarantee perfect functionality and low noise under all loads.

FUCHS AGRIFARM makes all the difference

The highest quality and the largest selection – guaranteed

With a broad portfolio of specially developed lubricant solutions, FUCHS AGRIFARM offers optimal all-round protection for your machines.

STOU

AGRIFARM STOU MC PRO SAE 10W-40
 AGRIFARM STOU MC SAE 10W-30
 AGRIFARM STOU MC SAE 10W-40
 AGRIFARM STOU SAE 15W-40

Engine

AGRIFARM MOT X-LA SAE 10W-40
 AGRIFARM MOT SAE 10W-40
 AGRIFARM MOT SAE 15W-40
 PLANTO MOT SAE 10W-40

Fette

RENOLIT CA-LZ (Spray:
 RENOLIT CA-LZ SPRAY)
 RENOLIT LX-Series
 RENOLIT FLM 2
 RENOLIT GP-Series 1/2/3
 RENOLIT LX-PEP 2
 RENOLIT LX-PEP 3
 RENOLIT MP PLUS
 RENOLIT LZR 2 H
 RENOLIT PASTE PW
 PLANTOGEL ECO 1 N



PLANTOGEL ECO 2 S (Spray: PLANTO
 MULTISPRAY S)



PLANTOGEL ECO 402 S

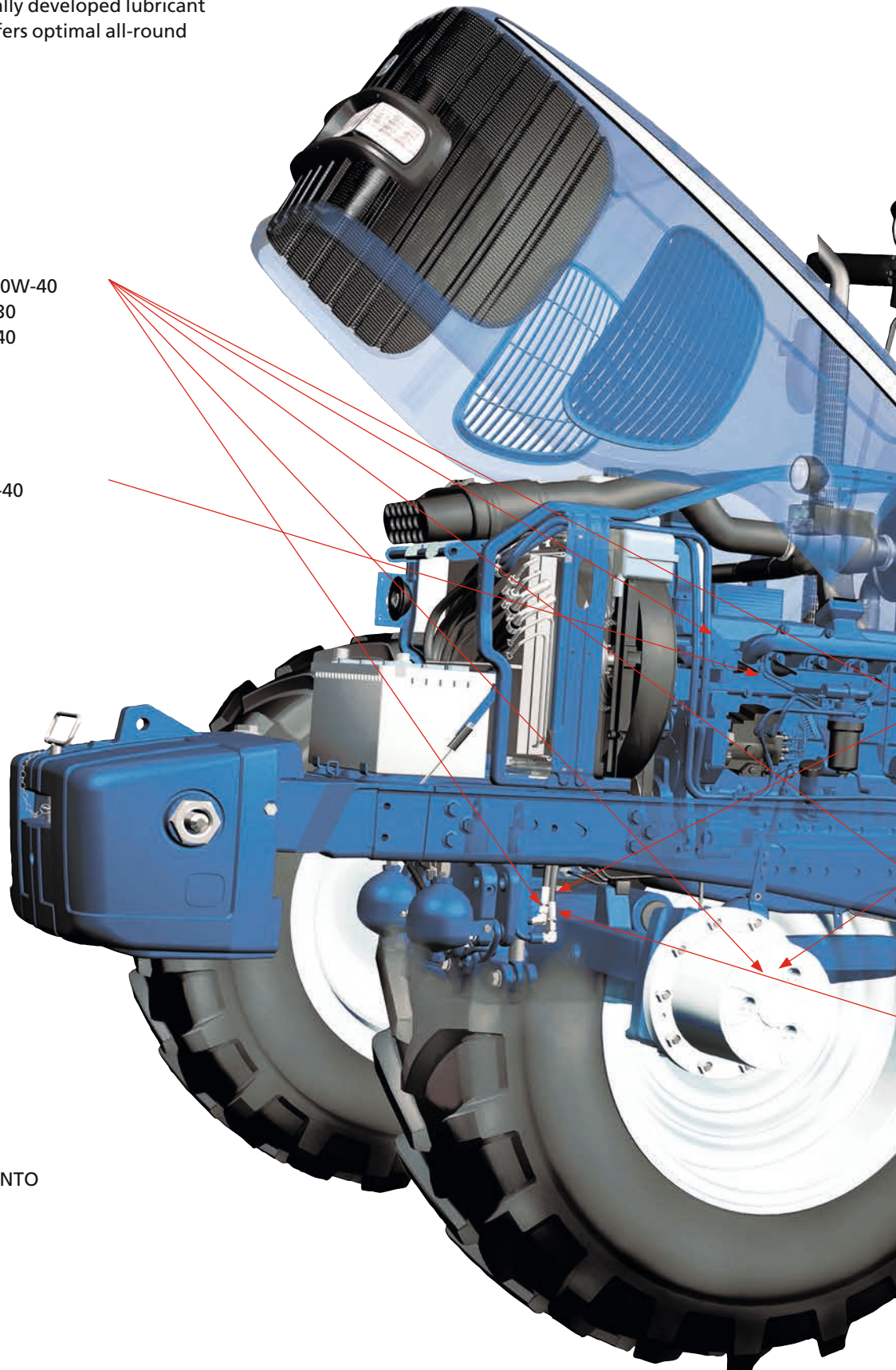

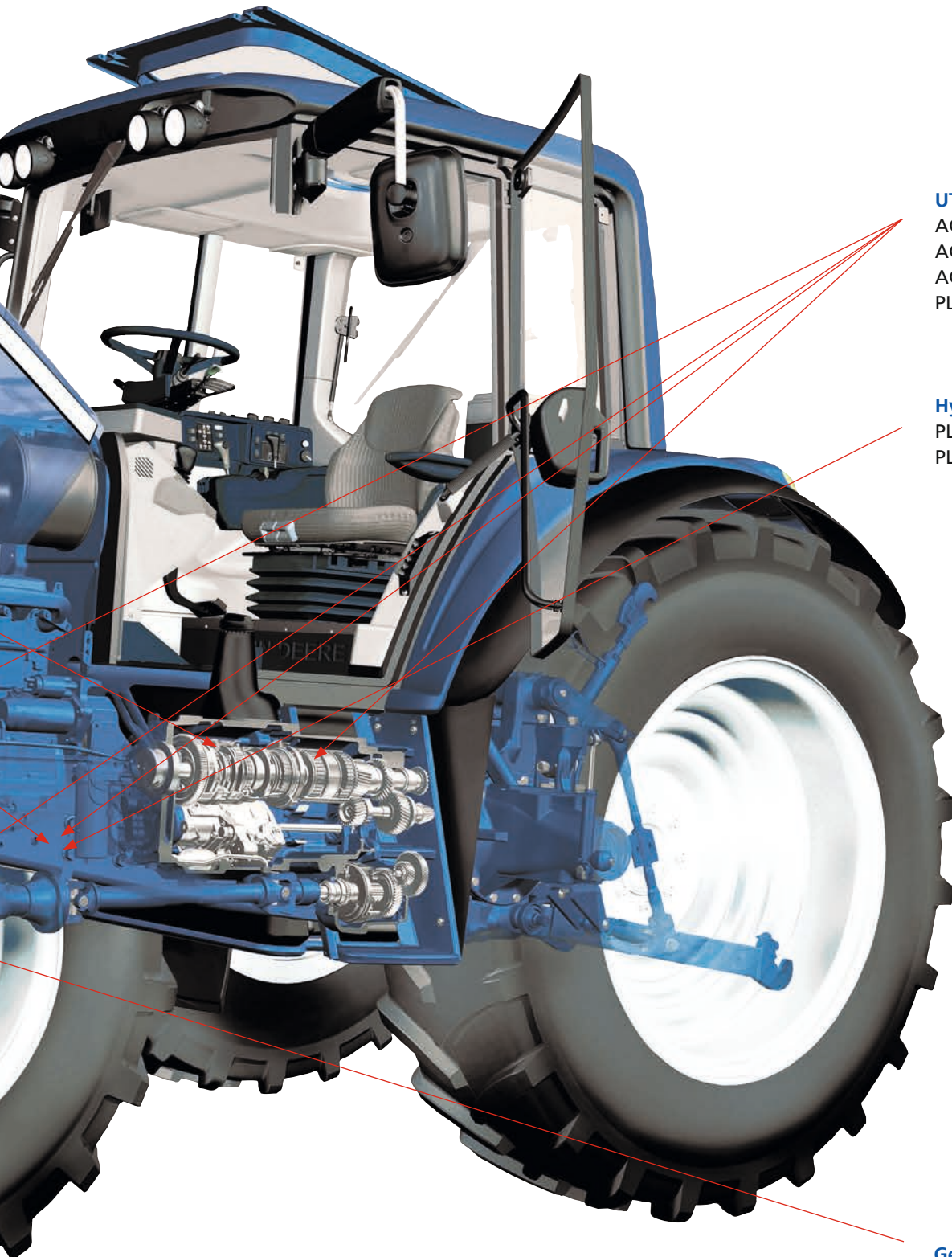

UTTO

AGRIFARM UTTO VT
 AGRIFARM UTTO MP
 AGRIFARM UTTO LN
 PLANTO HYTRAC PLUS

Hydraulic

PLANTOSYN 3268
 PLANTOSYN 3268 ECO

Gearbox

AGRIFARM GEAR LS SAE 90

AGRIFARM overview of products

Brand name	Description	Specifications	Approvals	FUCHS Recommendations
AGRIFARM STOU Oils				
AGRIFARM STOU MC PRO SAE 10W-40	Ultra High Performance Multifunctional Oil (STOU/MFO) of the latest generation for agricultural vehicles.	SAE J300: SAE 10W-40	DEUTZ DQC III-10	ACEA E7, E5, E4, E3, API CI-4, API GL-3/GL-4/API GL-5 in tractors* MAN 3275, AFNOR NFE 48603 HV ALLISON C-4 CASE MS 1207, 1209, 1210, 1230 CNH MAT 3505, 3509, 3525, 3526 DIN 51524-3 HVL P (-D) FNHA 2C-200.00, 201.00 FORD M2C48-C3, M2C86-B, M2C134-D, M2C159-B/C JOHN DEERE JDM J20C NEW HOLLAND 82009201/2/3 NH 030C, 330G, 330H, 410B, 420A, 526C MASSEY FERGUSON CMS M 1145, 1144, 1143, 1139, 1135 ZF TE-ML 06A, 06B, 06C, 06F, 06L, 07B *without HOLMER
AGRIFARM STOU MC SAE 10W-30	MC-Synthesis Super High Performance Multifunctional Oil (STOU/MFO) for engines, manual gearboxes, wet brakes, hydraulics and turbo-drives in tractors and other agricultural machinery.	API GL-4 SAE J300: SAE 10W-30	DEUTZ DQC I-02 ZF TE-ML 06B, 06F, 07B (ZF000733)	AFNOR NFE 48603 HV DIN 51524-3: HVL P (-D) ACEA E3 API CG-4 ALLISON C-4 CASE MS 1207, 1209, 1210, 1230 CNH MAT 3505, 3509, 3525, 3526 FORD M2C48-C3, M2C86-B, M2C134-D, M2C159-B/C JOHN DEERE JDM J20 C NEW HOLLAND 82009201/2/3 NH 410B, 420A MASSEY FERGUSON CMS M 1145, 1144, 1143, 1139, 1135 SAE J306: SAE 75W-80 ZF TE-ML 06A, 06C
AGRIFARM STOU MC SAE 10W-40	Super High Performance Multifunctional Oil (STOU/MFO) based on MC-base-oil technology for engines, manual gearboxes, wet brakes, hydraulics and turbo-drives in tractors and other agricultural and other commercial vehicles.	API GL-4 SAE J300: SAE 10W-40	DEUTZ DQC I-02 FENDT KDM 17/2012 ZF TE-ML 06B, 06F, 07B (ZF000729)	API GL-5 in tractors* ACEA E3 API CG-4 MAN 271 AFNOR NFE 48603 HV ALLISON C-4 CASE MS 1207, 1209, 1210, 1230 CNH MAT 3505, 3509, 3525, 3526 DIN 51524-3: HVL P (-D) FORD M2C134-D, M2C159-B/C FNHA 2C-200.00, 201.00 FORD M2C48-C3, M2C-86 B JOHN DEERE JDM J20C NEW HOLLAND 82009201/2/3 NH 030C, 330G, 410B, 420A, 526C MASSEY FERGUSON CMS M 1145, 1144, 1143, 1139, 1135 SAE J306: SAE 75W-90 ZF TE-ML 06A, 06C, 06L *without HOLMER

Brand name	Description	Specifications	Approvals	FUCHS Recommendations
AGRIFARM STOU Oils				
AGRIFARM STOU SAE 15W-40	High Performance Multifunctional Oil (STOU/MFO) for engines, manual gearboxes, wet brakes, hydraulics in tractors and other agricultural equipment.	API GL-4	FENDT KDM 17/2012	ACEA E2 API CF-4 CNH MAT 3525, 3526 DIN 51524: HLP (-D) FNHA 200.00, 201.00 FORD M2C 134-D, M2C 159-B/C JOHN DEERE JDM J20C MASSEY FERGUSON CMS M 1145, 1144, 1143, 1139, 1135 NEW HOLLAND 82009201/2/3 NH 420A SAE J306: 80W-90 SDFG OU 1391, OT 1891 STEYR D-401 ZF TE-ML 06A, 06B, 06C, 07B
AGRIFARM Engine Oils				
AGRIFARM MOT X-LA SAE 10W-40	Premium Performance Engine Oil for agricultural vehicles. Universal engine oil for application in modern vehicles with exhaust after treatment as well as in older vehicles. Best engine cleanliness and outstanding wear protection.	ACEA E9/E7/E6/E4 API CJ-4/ CI-4 PLUS/CI-4/ CH-4 CAT ECF-3	DEUTZ DQC IV-10 LA (incl. TTCD) MB-APPROVAL 228.51	CNH MAT 3521 CUMMINS CES 20081
AGRIFARM MOT SAE 10W-40	Ultra High Performance Engine Oil of the latest conception of the SAE grade 10W-40. It was developed for advanced diesel engines which made high demands on service intervals and engine cleanliness. Specially recommended for normally aspirated and turbocharged engines.	ACEA E7 API CI-4 GLOBAL DHD-1 JASO DH-1	–	ALLISON C-4 CAT ECF-2 CUMMINS CES 20071/2/6/7/8 DAF DEUTZ DQC III MACK EO-M PLUS MAN M 3275-1 MTU DDC TYPE 2 RENAULT RLD/RLD-2 VOLVO VDS-3
AGRIFARM MOT SAE 15W-40	Super High Performance Engine Oil for normally aspirated and turbocharged diesel engines in tractors and other machinery which make high demands on service intervals and engine cleanliness.	ACEA E7 API CI-4/SL GLOBAL DHD-1 CAT ECF-1-a/ECF-2	DEUTZ DQC III-10 MB-APPROVAL 228.3	ALLISON C-4 CAT TO-2 CASE MS 1121 CUMMINS CES 20071/2/6/7/8 DETROIT DIESEL 93K215 IVECO 18-1804 CLASSE T2 E7 MACK EO-N MAN M 3275-1 MTU DDC TYPE 2 NH 330H RENAULT RLD/RLD-2 STEYR A-201 VOLVO VDS-3

Note
The information contained in this brochure is based on the experience and expertise of FUCHS SCHMIERSTOFFE GMBH in the development and manufacture of lubricants and represents the current state of the art. The performance of our products can be influenced by a series of factors, especially the specific use, the method of application, the operational environment, component pretreatment, possible external contamination, etc. For this reason, it is not possible to make universally valid statements about the function of our products. Our products must not be used in aircraft/spacecraft or parts thereof. This does not apply insofar as the products can be removed again before components are fitted in an aircraft/spacecraft. The information given in this product information represents general, non-binding guidelines. No warranty expressed or implied is given concerning the properties of the product or its suitability for any given application. We therefore recommend that you consult a FUCHS SCHMIERSTOFFE GMBH application engineer to discuss application conditions and the performance criteria of the products before the products are used. It is the responsibility of the user to test the functional suitability of the products and to use them with the corresponding care. Our products are subject to continuous further development. We therefore retain the right to change our product range, the products, and their manufacturing processes as well as all details in this brochure at any time and without warning, provided that no customer-specific agreements exist that require otherwise.

With publication of this product information leaflet, all previous editions cease to be valid.
Any form of reproduction requires express prior written permission from FUCHS SCHMIERSTOFFE GMBH.

AGRIFARM overview of products

Brand name	Description	Specifications	Approvals	FUCHS Recommendations
AGRIFARM UTTO Oils				
AGRIFARM UTTO VT	Ultra High Performance Multifunctional Oil (UTTO/MFO) for use in transmission and hydraulic systems with integrated wet brakes, clutches and differentials for agricultural and construction machinery.	API GL-4	ZF TE-ML 06B, 06D, 06N, 07B (ZF002035)	ACEA E2 API CF-4/CG-4/SF ALLISON C-4 CAT TO-2 FORD M2C159-B/C JOHN DEERE JDM J20C JOHN DEERE JDM J27 MASSEY FERGUSON CMS M 1145 (1144, 1143, 1139, 1135) SAE J300: 10W-30 SAE J306: 80W-80 ZF TE-ML 06C, 06F, 06Q, 06R
AGRIFARM UTTO MP	Super High Performance Multifunctional Oil (UTTO/MFO) for use in transmission and hydraulic systems with integrated wet brakes, clutches and differentials for agricultural and construction machinery.	API GL-4	ZF TE-ML 03E, 05F, 17E, 21F, 06K (ZF001623)	AGCO Powerfluid 821 XL AGCO Q-186 (Whitefarm) ALLISON C-4 CASE MS 1230, 1210, 1209, 1207, 1206 CLAAS/LANDINI/SAME-Transmission CNH MAT 3505, 3506, 3509, 3525, 3526, 3540 FNHA-2-C-200.00/-201.00 FORD M2C48-C3, ESN M2C86-B/C, M2C134-D JOHN DEERE JDM J20C KUBOTA UDT FLUID MASSEY FERGUSON CMS M 1145, 1143, 1141, 1135 NH 410B SAE J300: 10W-30 SAE J306: 75W-80 SDFG OT 1891 A VALTRA G02-08, G2-B10
AGRIFARM UTTO LN	Super High Performance Transmission Hydraulic Fluid developed as a problem-solver for tractors in which conventional UTTO oils led to noisy wet brakes.	API GL-4 SAE J300: SAE 20W-30	–	AGCO Powerfluid 821 XL AGCO Q-186 (Whitefarm) ALLISON C-4 CASE MS 1206, 1207, 1209, 1210, 1230; CNH MAT 3505, 3506, 3509, 3525, 3526 FNHA-2-C-200.00/-201.00 FORD M2C48C3, ESN M2C86-B/C, M2C134-D JOHN DEERE JDM J20C MASSEY FERGUSON CMS M 1141, 1135 SAE J306: 80W-85 CLAAS/LANDINI/SAME-Transmission/DEUTZ-FAHR FENDT (non Vario)
AGRIFARM Gear Oils				
AGRIFARM GEAR LS SAE 90	Super High Performance EP Gear Oil for axles fitted with limited-slip differentials in agricultural and other machinery.	API GL-5	–	NH 520B SDFG OP 1705LS VOLVO 97310 ZF TE-ML 05C, 12C, 16E
AGRIFARM Milking Machine Oil				
AGRIFARM MILKING MACHINE OIL	Ultra High Performance Milking Machine Oil specially developed for use in the vacuum pumps of milking machines. It contains additives which protect against wear and corrosion and foaming. These features increase the functional reliability of such systems.	–	–	ALFA LAVAL WESTFALIA

FUCHS Oil Chooser

It could hardly be easier:

Our Oil Chooser can be found at www.fuchs.com/de/en.

Simply choose your vehicle type and select the make and model. A window appears with an overview of the optimum lubricants for your vehicle. All you have to do is click on the appropriate application and you will be shown the product you require.



Direct link to [FUCHS Oil Chooser](#)

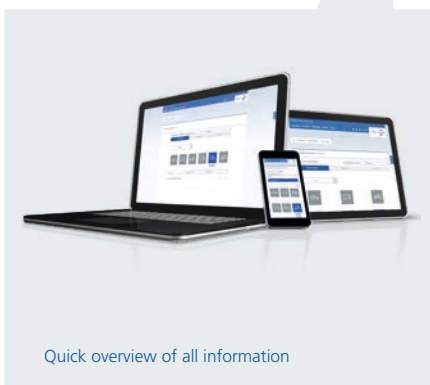

Quick overview of all information

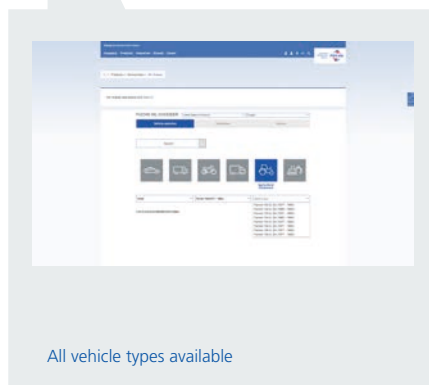

All vehicle types available

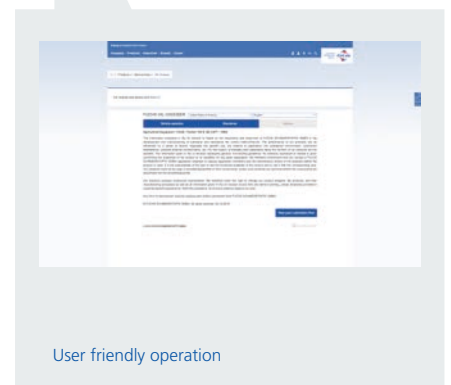

User friendly operation

PLANTO REAL BIOGENIC LUBRICANTS









Forests, fields and grasslands are highly sensitive ecosystems and their modern utilization has long had to be economically viable.

Virtually all vehicles operate outdoors in one way or another, carrying all manner of resources on board such as fuels, lubricants and antifreeze. This presents a not inconsiderable danger to us and our environment in the event of a spillage or accident.

These dangers can be avoided by using special lubricants. FUCHS focuses on sustainability and economic efficiency and for this reason offers a multitude of rapidly biodegradable products for your applications.

PLANTO overview of products

Brand name	Description	Specifications	Approvals	FUCHS Recommendations
Rapidly Biodegradable Lubricants				
PLANTO MOT SAE 10W-40	Low-ash diesel engine oil for modern diesel engines. Biodegradable and especially recommended for use with alternative diesel fuels.	–	DEUTZ DQC IV-18 LA	ACEA E7/E6 API CK-4
PLANTOSYN 3268 	Environmentally Friendly, HVI Multigrade Hydraulic Oil with high temperature stability based on fully-saturated, synthetic esters (HEES), rapidly biodegradable according to OECD 301 B >60 %, awarded with the EU Ecolabel.	ISO 15380: HEES DIN 51524-3: HVLP (Exception: Dry TOST)	FENDT	O&K BAUMASCHINEN
PLANTOSYN 3268 ECO 	Environmentally Friendly, HVI Multigrade Hydraulic Fluid based on partly saturated synthetic esters (HEES), universally applicable, rapidly biodegradable according to OECD 301 B >60 %, awarded with the EU Ecolabel.	DIN 51524-2: HLP (Exception: Dry TOST) DIN 51524-3: HVLP (Exception: Dry TOST) ISO 15380: HEES	FENDT KDM 28/2006	–
PLANTO HYTRAC PLUS	Biodegradable Super High Performance Multifunctional Oil (UTTO) for tractor gearboxes with or without wet brakes.	SAE 10W-30 SAE 80	–	Several makes of tractors
PLANTO TAC 68 	Biodegradable Super High Performance Chain Saw Oil based on rapeseed. For professional use in chain saws. Excellent lubricity and good ageing stability, awarded with the EU Ecolabel.	–	KWF	DOLMAR HUSQVARNA SOLO STIHL

Product Name	Classification DIN 51502 ISO 6743-9	Thickener Base oil	Solid lubricants	NLGI grade	Base oil viscosity at 40 °C [mm ² /s]	Temperature range [°C]	Approval, recommendations	Main field of application
Rapidly Biodegradable Greases								
PLANTOGEL ECO 1 N 	–	Calcium Rape seed oil	–	1	36	-20 / +80	EU ECOLABEL	Rapidly biodegradable lubricating grease with Ecolabel, e.g. for lock gates or in agriculture and forestry.
PLANTOGEL ECO 2 N 	–	Calcium Rape seed oil	–	2	36	-20 / +80	EU ECOLABEL	Rapidly biodegradable lubricating grease with Ecolabel, e.g. for lock gates or in agriculture and forestry.
PLANTOGEL ECO 2 S (Spraydose: PLANTO MULTISPRAY S) 	–	Li/Ca synth. Ester	–	2	110	-40 / +120	EU ECOLABEL	Rapidly biodegradable EP multipurpose grease for plain and roller bearing lubrication, e.g. water turbines or in agriculture and forestry. Good pumpability in central lube systems.
PLANTOGEL ECO 402 S 	–	Ca synth. Ester	–	2	390	-40 / +120	EU ECOLABEL	High performance bio-grease, water (salt water) resistant.

RENOLIT LUBRICATING GREASES FOR YOUR UNITS

Lubricating greases are consistent lubricants made up of base oil and a specially chosen thickener. To increase certain properties, additives are added to the lubricating greases.

Lubricating greases are structural elements, especially when used as long-life lubricants for lifetime lubrication.

RENOLIT lubricating greases are a balanced and complete package offering the ideal technical and economical solution in the largest possible number of lubricating grease applications in agriculture.

RENOLIT overview of products

Product Name	Classification DIN 51502 ISO 6743-9	Thickener Base oil	Solid lubricants	NLGI grade	Base oil viscosity at 40 °C [mm ² /s]	Temperature range [°C]	Approval, recom- mendations	Main field of application
Greases								
RENOLIT CA-LZ (Spray can: RENOLIT CA-LZ SPRAY)	KP2K-30 ISO-L-X-CCHB2	Calcium Min.-oil	–	2	700	-30 / +120	–	Strongly adhesive, protects from wear even under extreme conditions, very resistant to water wash-out from metallic surfaces, longterm lubrication of passenger cars and commercial vehicles, construction industry, industrial and agricultural machines.
RENOLIT FLM 2	KPF2N-30 ISO-L-X-CDEB 2	Lithium Min.-öl	X	2	100	-30 / +140	MAN 285 LI-PF 2	For mechanically loaded lubricating points, grease with MoS ₂ , agricultural machines, commercial vehicles, construction industry, quarries and mining, rubber and concrete factory.
RENOLIT GP-SERIES 1/2/3	K1K-30 ISO-L-X-CCEA 1 K2K-30 ISO-L-XCCEA 2 K3K-30 ISO-L-XCCEA 3	Lithium Min.-öl	–	1/2/3	110	-30 / +120	–	Ageing resistant multi-purpose grease with good corrosion protection properties for lubrication of plain and roller bearings, easily pumpable in central lubricating systems.
RENOLIT LX-PEP 2	KP2N-30 ISO-L-X-CDEB 2	Li-X Min.-oil	–	2	170	-30 / +150	MAN 284 Li-H2, MB 265.1, ZF TE-ML 12, Schaeffler Gruppe, VW TL 52 147 X, Interprecise (IDC-Bearings), Deutsche Bahn	Multipurpose grease, wheel bearings of motor vehicles, roller bearings of e-motors, needle bearings of cardan shafts, plain and roller bearings, ventilator grease.
RENOLIT LX-PEP 3	KP3N-30 ISO-L-X-CDEB 3	Li-X Min.-oil	–	3	170	-30 / +150	Interprecise (IDC-Bearings)	Multipurpose grease, wheel bearings of motor vehicles, roller bearings of e-motors, plain and roller bearings, ventilator grease.
RENOLIT LZR 2 H	KP2N-30 ISO-L-X-CDIB 2	Lithium Min.-oil	–	2	230	-30 / +160	Baier & Köppel	Premium multi-purpose grease, long-term rust prevention, sealing grease, central lubricating systems, sugar refineries, roof tile factories, paper industry, prevent stand-still corrosion, hytel compatibel.
RENOLIT MP PLUS	KP2K-30 ISO-L-X-CCEB 2	Lithium Min.-oil	–	2	100	-30 / +120	–	High quality EP multipurpose grease with high adhesiveness for the lubrication of plain and roller bearings. Only available in SR cartridges.
RENOLIT PASTE PW	–	CaSX Min.-oil	X	2	350	-20 / +1200	–	Assembly paste for prevent fretting corrosion, e.g. gears, electrical motors, etc., chucks, superheated steam valves, bearing seats on knuckle pins, or spline connections in length adjusters of cardan shafts.

FUCHS lubricants

Innovative lubricants need experienced application engineers

Every lubricant change should be preceded by expert consultation on the application in question. Only then can the best lubricant system be selected. Experienced FUCHS engineers will be happy to advise on products for the application in question and also on our full range of lubricants.

Contact:



FUCHS SCHMIERSTOFFE GMBH
Friesenheimer Straße 19
68169 Mannheim/Germany
Phone: +49 621 3701-0
Fax: +49 621 3701-7000
E-mail: zentrale-fs@fuchs.com
www.fuchs.com/de/en

Export Division
Friesenheimer Straße 19
68169 Mannheim/Germany
Phone: +49 621 3701-1713
Fax: +49 621 3701-7713
E-mail: export-fs@fuchs.com
www.fuchs.com/de/en